

1
2
3
4
5
6
7
8
9
10
11
12
13
14
15
16
17
18
19
20
21
22
23
24
25
26
27
28

UNITED STATES DISTRICT COURT
NORTHERN DISTRICT OF CALIFORNIA

FLUIDIGM CORPORATION, et al.,

Plaintiffs,

No. C 19-05639 WHA

v.

IONPATH, INC.,

Defendant.

**ORDER ON SUMMARY
JUDGMENT**

INTRODUCTION

Cross motions for summary judgment dispute the validity of asserted patents and their infringement by certain accused products. The technology at issue, mass cytometry, involves analysis of biological tissue samples via mass spectrometry. The properly construed claims preclude literal infringement and patent owner has abdicated its burden under the doctrine of equivalents. Defendant’s motion is **GRANTED IN PART**.

STATEMENT

Prior orders detail the facts here (Dkt. Nos. 46, 58, 143). In brief, plaintiff Fluidigm Corporation has developed mass cytometry methods and systems for cell structure and biomarker analysis, disclosed in U.S. Patent Nos. 10,180,386 and 10,436,698. These methods involve labelling a sample, a cell or clump of cells, with metal tags attached to antibodies in a process called “staining.” Different antibodies bind to different analytes (organic material of interest in the sample) and different metal tags attach to different antibodies. Following

1 staining and washing, to remove unbound antibodies, only antibody-metal tags bound to
2 present analytes remain.

3 Sample analysis begins with vaporization, atomization, and ionization of the samples and
4 metal tags. A mass spectrometer then measures the mass-to-charge ratio of the ions and, using
5 the different weights of different metals, identifies the various metal tags released from the
6 sample. And, because the various metal tags bound to antibodies which in-turn bound to
7 specific analytes, identifying the metal tags identifies the analytes present in the sample. Apart
8 from the patents covering this process, patent owner also sells its own line of embodying
9 products, but those are irrelevant here (Dkt. No. 161-4).

10 Defendant IONpath, Inc. competes in the same market. The complaint charges defendant
11 with intentional interference with patent owner's contractual relations with customers, but that
12 charge does not come into play here. Our present dispute, instead, centers on patent owner's
13 claims of patent infringement by defendant's accused product, the MIBIScope.

14 The parties do not dispute how the MIBIScope functions. Similar to patent owner's
15 methods, the MIBIScope analyzes antibody-metal-tag stained biological samples with mass
16 spectrometry. And again, as with patent owner's methods, each antibody-metal tag attaches to
17 a unique analyte. So identification of a metal tag will in turn identify an analyte in the sample.
18 Unlike the claimed invention, though, which operates on cells, the MIBIScope operates on
19 thinly sliced tissue samples (around four micrometers thick, much thinner than any intact cell
20 might be) mounted onto a slide.

21 For the accused analysis, a narrow beam of high-energy ions bombards the sample. The
22 beam "rasters across the sample," that is, the beam traces row by row across the sample, just as
23 a cathode-ray tube television projects onto a screen.

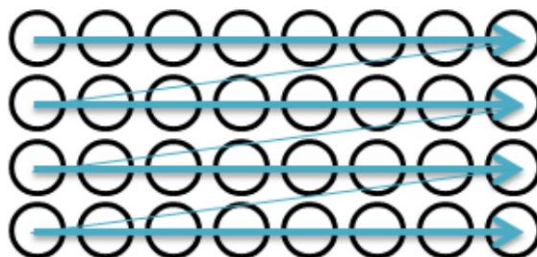

28

1 The ion beam can be trained to hit quarter-micrometer elements as it traces along the sample.
2 As the beam hits each element, it ionizes or “ablates” the metal tags within that element (and
3 not the surrounding ones) for introduction into and identification by the mass spectrometer.

4 The description of this sequence as “pixel-by-pixel” is somewhat of a misnomer, as the
5 elements on the sample are not themselves pixels on a screen. But the MIBIScope preserves
6 the location as it scans each element of a sample for mapping to a corresponding pixel in post-
7 processing, making the phrase “pixel-by-pixel,” if not entirely accurate, descriptively effective.
8 As shown in the figure below, the MIBIScope uses this data to produce a map which displays
9 the presence (or not) of desired analytes across a sample. Further software processing also
10 allows the MIBIScope to estimate the locations of cell borders within the sample (Dkt. Nos.
11 158-6 at 5–6; 161-4 at 4–5, 17–18).

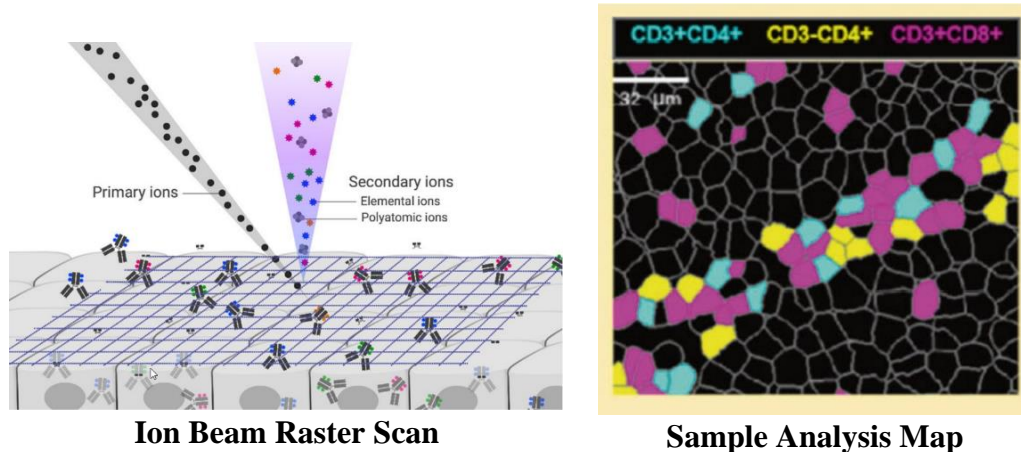

12
13
14
15
16
17
18
19 Following several iterations of the complaint and a few rounds of infringement and
20 invalidity contention amendment, we now reach our first taste of the merits in our patent
21 “showdown.” Each side has chosen the single claim it finds most promising for its cause.
22 Patent owner has chosen Claim 9 of the ’386 Patent; defendant, Claim 6 of the ’698 Patent.
23 The claims are substantially similar, and the patents share a single specification, so patent
24 owner moves for summary judgment of validity and the MIBIScope’s infringement of both,
25 and defendant moves for summary judgment of noninfringement and invalidity of both. It also
26 moves to strike patent owner’s expert report and portions of the motion which it asserts to be
27 directed toward newly, and untimely, accused versions of the MIBIScope. This order follows
28 full briefing and oral argument held telephonically due to public health and security crises.

1
2
3
4
5
6
7
8
9
10
11
12
13
14
15
16
17
18
19
20
21
22
23
24
25
26
27
28

ANALYSIS

Summary judgment is appropriate if there is no genuine dispute of material fact, those facts “that might affect the outcome of the suit.” “[T]he substantive law’s identification of which facts are critical and which facts are irrelevant . . . governs.” A genuine dispute contains “sufficient evidence” such that a “reasonable jury could return a verdict for the nonmoving party.” *Anderson v. Liberty Lobby*, 477 U.S. 242, 248–49 (1986). “In judging evidence at the summary judgment stage, the court does not make credibility determinations or weigh conflicting evidence. Rather, it draws all inferences in the light most favorable to the nonmoving party.” *Soremekun v. Thrifty Payless, Inc.*, 509 F.3d 978, 984 (9th Cir. 2007). If “a proper jury question” remains, summary judgment is inappropriate. *See Anderson*, 477 U.S. at 249.

Patent infringement requires that an accused product practices every limitation of a properly construed claim. *See Tessera, Inc. v. Int’l Trade Comm’n*, 646 F.3d 1357, 1364 (Fed. Cir. 2011). Our dispute focuses on the independent claims underlying the asserted dependent claims.

’386 Patent, Claim 9

’698 Patent, Claim 6

1. A method of *sequentially* analyzing single cells by mass spectrometry, comprising:

providing a sample containing a plurality of tagged cells tagged with a plurality of tagged antibodies, wherein each of the tagged antibodies is specific for a different analyte, and wherein each of the tagged antibodies is tagged with an elemental tag comprising a lanthanide or noble metal;

vaporizing, atomizing, and ionizing multiple elemental tags from a single first cell of the plurality of tagged cells;

detecting, using mass spectrometry, the elemental composition of the first cell by detecting a transient signal of the multiple vaporized, atomized, and ionized elemental tags of the first cell;

1. A system for *sequentially* analyzing single cells in a sample by mass spectrometry,

wherein the sample comprises a plurality of tagged cells tagged with a plurality of tagged antibodies, wherein each of the plurality of tagged antibodies is specific for a different analyte, and wherein each of the plurality of tagged antibodies is tagged with an elemental tag comprising a lanthanide or noble metal;

wherein the system comprises:

a first device to vaporize, atomize, and ionize multiple elemental tags from a single first cell of the plurality of tagged cells and multiple elemental tags from a single second cell of the plurality of tagged cells; and

1 vaporizing, atomizing, and ionizing
2 multiple elemental tags from a single
3 second cell of the plurality of tagged cells;
4 and

5 detecting, using mass spectrometry, the
6 elemental composition of the second cell
7 by detecting a transient signal of the
8 multiple vaporized, atomized, and ionized
9 elemental tags of the second cell, wherein
10 the transient signal associated with the
11 first cell and the transient signal
12 associated with the second cell are
13 detected *sequentially*.

14 9. The method of claim 1, wherein each
15 of the plurality of tagged antibodies is
16 tagged with a distinct isotope.

17 a second device to detect, by mass
18 spectrometry, lanthanides and/or noble
19 metals of the single first cell by detecting
20 a transient signal of the multiple
21 vaporized, atomized, and ionized
22 elemental tags of the single first cell, and
23 lanthanides and/or noble metals of the
24 single second cell by detecting a transient
25 signal of the multiple vaporized,
26 atomized, and ionized elemental tags of
27 the single second cell, wherein the
28 transient signal associated with the single
first cell and the transient signal
associated with the single second cell are
detected *sequentially*.

6. The system of claim 1, wherein each of
the plurality of tagged antibodies is tagged
with a distinct isotope.

Specifically, our dispute turns on the meaning of detecting signals from cells “sequentially”
and whether that meaning covers the MIBIScope’s pixel-by-pixel ablation across a sample.

1. CONSTRUCTION OF “SEQUENTIALLY.”

Patent owner advances a temporal limitation, construing “sequentially” merely as
detecting signals from cells “at separate times,” and argues that this interpretation covers pixel-
by-pixel ablation, as portions of different cells would be ablated and the associated signals
detected at separate times. Defendant disagrees and argues that the term requires individual
analysis and detection of such signals on a “cell-by-cell basis.” This claim scope, defendant
argues, excludes pixel-by-pixel ablation which does not analyze a complete cell before moving
to the next, but instead scans portions of several cells along a row of pixels before looping back
to scan other portions *of those same cells* in the next row of pixels.

Claim terms generally take “their ordinary and customary meaning,” that is “the
meaning that the term would have to a person of ordinary skill in the art in question at the time
of the invention.” Though we begin with the claim language itself, “*the specification is the
single best*” — and usually dispositive — “guide to the meaning of a disputed term.” *Network-
1 Techs., Inc. v. Hewlett-Packard Co.*, 981 F.3d 1015, 1022 (Fed. Cir. 2020); *Phillips v. AWH
Corp.*, 415 F.3d 1303, 1312–13, 1315 (Fed. Cir. 2005) (en banc) (emphasis added). This does
not grant us free rein to import limitations from the specification into the claims, particularly

1 where such operative language does not appear in the claim itself. *Amgen Inc. v. Hoechst*
2 *Marion Roussel, Inc.*, 314 F.3d 1313, 1325 (Fed. Cir. 2003). Nevertheless, the specification
3 remains the text for term construction because “the words of the claims *must* be based on the
4 description.” *Phillips*, 415 F.3d at 1315 (citing *Standard Oil Co. v. Am. Cyanamid Co.*, 774
5 F.2d 448, 452 (Fed. Cir.1985)) (emphasis added).

6 This order adopts a hybrid construction. “Sequentially,” as used in the asserted patents
7 requires a cell-by-cell, complete analysis. This includes patent owner’s proposed temporal
8 limitation, that the detection of transient signals from different cells occurs at separate times. It
9 also includes defendant’s proposed cell-by-cell limitation. And, it includes a completeness
10 requirement, meaning, in our context, that once a cell analysis has been undertaken, it will be
11 completed and it will not be repeated.

12 This cell-by-cell requirement stems from the term itself. A “sequence,” as “the following
13 of one thing after another in succession,” certainly includes patent owner’s temporal
14 requirement. Instead of simultaneous events, one follows another. But a “sequence” includes
15 more. It does not connote an intermingling between steps, a bit of “one thing” here, then a bit
16 of “another” thing, and then a little more of the “one thing.” Rather, the ordinary meaning for
17 one asked to perform several tasks in sequence is to complete each task before moving to the
18 next. *See sequence*, Oxford English Dictionary Online, [https://www.oed.com/view/Entry](https://www.oed.com/view/Entry/176289#eid23309112)
19 [/176289#eid23309112](https://www.oed.com/view/Entry/176289#eid23309112) (last accessed Jan. 28, 2021).

20 Context confirms this use of the term. The asserted claim limitations recite “wherein the
21 transient signal associated with the [single] first cell and the transient signal associated with the
22 [single] second cell are detected sequentially.” Consistent with this, both preambles (though
23 our parties dispute whether they limit the claims) recite “sequentially analyzing single cells [in
24 a sample] by mass spectrometry.” In other words, the *cells themselves*, not some smaller entity
25 (such as pixels), distinguish between steps in the sequence. We first detect one set of transient
26 signals *from one cell*, then at a separate time, we detect another set *from another cell*. The
27 nature of the invention itself confirms that the claims operate cell-by-cell with no repeats.
28 Patent owner’s Dr. Gary Hieftje admits that in the basis for the invention, “mass cytometry[,]”

1 by definition the cell has to be destroyed” (Dkt. No. 160-13 at 110). After all, it “vaporize[s],
2 atomize[s], and ionize[s]” the cells for analysis. Patent owner offers no argument, and this
3 order discerns no concept from the claims or specification, that the cells could reform after this
4 treatment. So, as each cell enters the invention, one-by-one, for vaporization, atomization,
5 ionization, and analysis, that’s it.

6 The specification illustrates this requirement. The best mode requires and indeed, as
7 Figure 1 of the patents indicates, begins with a “Means for Introducing Particles Sequentially”
8 into the devices for vaporization and detection (’386 Pat. at 11:53–56). Figures 2 and 3 (in
9 relevant part) show the invention introducing particles, *one-by-one* for vaporization,
10 atomization, ionization, and analysis. Figure 4 illustrates a device for such one-by-one
11 introduction.

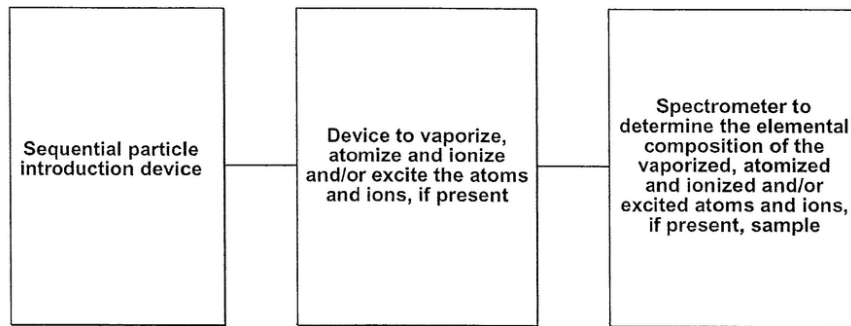

12 **Figure 1 of the '386 Patent**

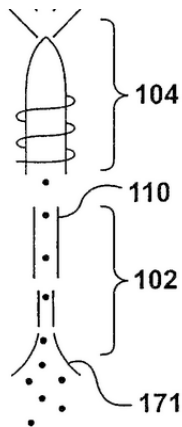

13
14
15
16
17
18
19
20
21
22
23
24
25 **Figures 2 and 3 (in relevant part)**

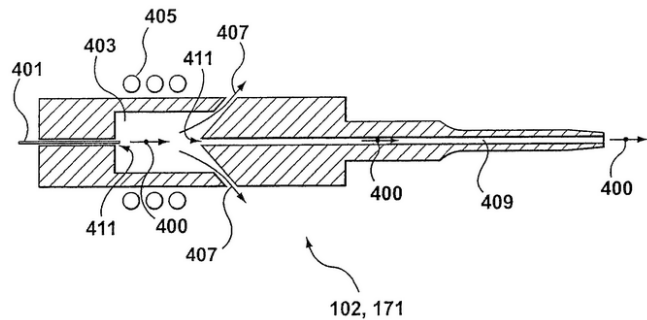

26 **Figure 4**

27 Then, rather than describe an alternate embodiment of the invention in which particles
28 might be introduced *en masse* for grouped analysis, the specification instead proceeds to
describe a prime obstacle to overcome in single particle introduction, that of larger particles

1 not being fully vaporized, atomized, and ionized effectively for the mass spectrometry. “[I]t is
2 desirable,” the specification explains, “that the entire particle . . . be vaporized, and at least
3 partially atomized and ionized, so as to enable determination of the element tags contained
4 within the particle.” Due to the brief time the particle passes through the system, though, “the
5 heat transfer to a large particle [may be] insufficient to allow complete vaporization,
6 atomization[,] and ionization.” But that problem arises usually with solid particles. Cells, the
7 specification explains, often explode upon rapid heating into fragments small enough for
8 vaporization, atomization, and ionization. And, if that solution fails, the specification
9 describes “in-line lysis” as an alternate method of rupturing cells for fragmented vaporization,
10 atomization, and ionization (’386 Pat. at 12:24–67).

11 These solutions manifest in some unasserted dependent claims, but nevertheless inform
12 the construction of the independent claims which though they would not require them must
13 nevertheless encompass them. *See Liebel-Flarsheim v. Medrad, Inc.*, 358 F.3d 898, 910 (Fed.
14 Cir. 2004); *Wahpeton Canvas Co., Inc. v. Frontier, Inc.*, 870 F.2d 1546, 1553 (Fed. Cir. 1989).
15 Note, though, that even in these embodiments, the fragments come from “the first cell” (’386
16 Pat. at Claims 3, 4). Neither the claims nor the specification give any indication that one
17 fragment from one cell might be vaporized and analyzed, then a fragment from another, and
18 then another fragment from the earlier cell. Moreover, the rupture or explosion remains
19 irreversible, with no hint that the cell might be reconstituted for later vaporization and analysis.

20 All this is to say, the term “sequentially” carries into the claims the requirement that the
21 subject particles, here cells, are introduced one-by-one into the system for vaporization,
22 atomization, ionization, and then analysis. And, rather than encompassing partial treatment of
23 cells at different times, the term “sequentially” means that once a cell is vaporized, atomized,
24 ionized, and analyzed, the process is complete. There’s no second round for that cell.

25 Patent owner objects that this construction improperly imports limitations from the best
26 mode into the claims. Not so. Our construction of “sequentially” must comport with the
27 patents in their entireties — the claim limitations and the preambles, the specification and the
28 best mode, and the drawings. *See Phillips*, 415 F.3d at 1315–16 (citing *Markman v. Westview*

1 *Insts.*, 517 U.S. 370, 389 (1996)). And, the asserted claims themselves include the term
2 “sequentially,” so the question before us is not one of importing limitations but of construing
3 those already present. By arguing against incorporation of the entirety of the term
4 “sequentially,” patent owner in essence seeks to expand the scope of the invention. This it may
5 not do.

6 The purpose of the written description requirement is to prevent an
7 applicant from later asserting that he invented that which he did
8 not; the applicant for a patent is therefore required to “recount his
9 invention in such detail that his future claims can be determined to
10 be encompassed within his original creation.”

11 *See Amgen*, 314 F.3d at 1325, 1330.

12 Here, moreover, the requirement of “sequential[.]” cell analysis does not appear only in
13 the best mode — rather, it pervades the specification. Both the ’368 and ’698 patents disclose
14 methods and apparatuses “for *introducing particles sequentially* and analyzing the particles
15 (for example, single particles such as single cells or single beads), by spectrometry” (’368 pat.
16 at 2:55–58). The specification explains that “particles” may include multi-cellular bunches,
17 “the term ‘means for introducing single particles sequentially’ . . . may encompass introduction
18 of a predetermined number of particles (for example, 2 or more),” but confirms that particles
19 still come “in discrete ‘packets’” (’386 Pat. at 2:66–3:2). Including these two examples, *every*
20 articulation in the “Summary of the Invention,” involves sequential introduction of discrete
21 particles or bunches of particles:

- 22 • The instrument has a sample introduction system for
23 generating a stream of particles from a sample (’386 Pat. at
24 3:16–17, 3:31–33);
- 25 • The ionization system is operable to atomize particles in
26 the stream as the particles are received from the sample
27 introduction system (’386 Pat. at 3:19–21);
- 28 • [T]he stream of particles produced by the sample
introduction system (’386 Pat. at 3:35–36);
- In another broad aspect, the invention provides a method
for analyzing particles that have been introduced
sequentially, such as single cells or single beads (’386 Pat.
at 3:42–44);

1
2
3
4
5
6
7
8
9
10
11
12
13
14
15
16
17
18
19
20
21
22
23
24
25
26
27
28

- Another aspect of the invention is an elemental flow cytometer, comprising: a means for introducing particles sequentially into a device ('386 Pat. at 3:49–51);
- Another aspect of the invention is a mass-spectrometer-based flow cytometer, comprising: a means for introducing particles sequentially into a device ('386 Pat. at 3:59–61, 4:1–3);
- Another aspect of the invention, is an optical emission spectrometer-based flow cytometer, comprising: a means for introducing particles sequentially into a device ('386 Pat. at 4:14–16);
- Another aspect of the invention, is a method of analyzing particles that have been introduced sequentially into a device ('386 Pat. at 4:26–27).

Even the prosecution history highlights the importance of individual, cell-by-cell analysis. Distinguishing prior art which “detect[ed] a sample in bulk,” patent owner highlighted the “importance of single cell analysis” to its invention and the ability to distinguish between the analyses of individual cells (Dkt. Nos. 179-4 at 9; 180-5 at 8).

Simply put, even bearing in mind the Federal Circuit’s caution against needless importation of limitations from the specification into the claims, “the specification makes plain what [Fluidigm] did and did *not* invent.” *See Phillips*, 415 F.3d at 1315 (citing *In re Fout*, 675 F.2d 297, 300 (CCPA 1982)) (emphasis added). Read in light of the specification of which they are a part, the asserted claims’ “sequential[.]” cellular-signal detection means cell-by-cell introduction and completion of the analysis each time.

2. LITERAL NONINFRINGEMENT.

Our construction of “sequentially” precludes direct infringement. Again, patent owner asserts that the MIBIScope infringes because it scans linearly, pixel-by-pixel across multiple cells, and so detects transient signals from multiple cells at different times (Dkt. No. 161-4 at 17–18). There appears no dispute that the MIBIScope satisfies the temporal limitation of “sequentially.” It scans different elements of the sample at separate times. So far so good. But that’s as far as the similarities go on this limitation. The claims and the MIBIScope *target* fundamentally different subjects both physically and conceptually. On the one hand, the claims physically target cells and conceptually scan *cell-by-cell*. On the other hand, the

1 MIBIScope operates on four-micrometer-thick tissue slices, not full cells, and raster scans
2 *pixel-by-pixel*. The sample may contain slivers from multiple cells, so some pixels may fall on
3 some cells and some on others; but the MIBIScope doesn't care (Dkt. No. 162-12 at 2, 4; 161-
4 13).

5 This matters because of the destructive nature of cell analysis in the invention so
6 conceived. Recall, patent owner's Dr. Hieftje admitted that the claimed invention requires
7 destruction of each cell upon "vaporization, atomization, and ionization" in preparation for the
8 mass spectrometry analysis (Dkt. No. 160-13 at 110, 408). Any analysis to be performed *must*
9 be performed in that single round following cellular destruction. The claimed "detect[ion]"
10 compete, the cell cannot be reconstituted for another round.

11 On the contrary, the MIBIScope, proceeding pixel-by-pixel, detects a little from one cell,
12 a little from another, and perhaps a little from several more, before returning to the next row of
13 pixels in the sample to analyze a different portion *of the same cells already analyzed*. If the
14 MIBIScope performed anything in sequence as the claims require, it would be the pixel-by-
15 pixel scanning and analysis. This, defendant's expert, Dr. Nicholas Winograd, appeared to
16 admit at deposition, although even this point rests on shaky ground given he and counsel did
17 not apply the term "sequentially" as used by the claims, and instead employed the generic
18 definition (Dkt. No. 161-5 at 86-87, 116-17). It is also worth noting on this point that any
19 equivalence breaks down further because the MIBIScope's ion-beam does not destroy the
20 sample as the claims do. Patent owner's own submissions to the record make clear that "[t]he
21 MIBIScope platform is also minimally destructive to the tissue, permitting additional tissue re-
22 scans at different resolutions to acquire Z-depth information or enabling other multi-omic
23 analyses post-acquisition" (Dkt. No. 161-13 at 1). So, even scanning pixel-by-pixel, the
24 MIBIScope might still return to a previously-scanned pixel of the same sample to gather new
25 data. All this is to say that the MIBIScope does not perform the cell-by-cell, complete analyses
26 as claimed in the patents.

27 This, of course, makes practical sense. Patent owner broadly paints the similarities
28 between the claims and the MIBIScope, but their outputs fundamentally differ beyond the

1 distinction between cells versus pixels. The claimed invention focuses on *single cells* because
2 the “analy[sis of] single particles can provide greatly improved accuracy, large dynamic range
3 and high sensitivity, compared to prior art systems” (’386 Pat. at 1:40–2:6, 8:14–17). The
4 MIBIScope operates differently to a different end. By scanning tissue samples pixel-by-pixel,
5 patent owner admits that the MIBIScope “preserves spatial information,” meaning that the
6 mass spectrometry results may be “mapped to each pixel” to generate an image (as below)
7 displaying an analyte’s presence (or not) across the sample (Dkt. No. 161-4 at 18):

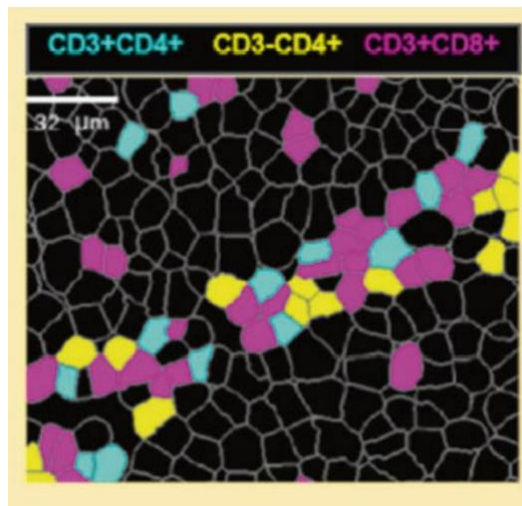

Sample Analysis Map

8
9
10
11
12
13
14
15
16
17 Patent owner never explains how the asserted claims could accomplish this location
18 preservation in spite of vaporizing, atomizing, and ionizing the subject cells. The best mode
19 appears to disclaim such location preservation, noting the utility of cells exploding into more
20 easily vaporized, atomized, and ionized fragments upon initial heating. So too, the in-line lysis
21 embodied in the related (though unasserted) dependent claims describes rupturing cells before
22 analysis. True, the claims do not explicitly admit to the cell fragments’ unknown locations.
23 But the specification provides no basis to conclude that the invention conceives of the
24 MIBIScope’s spatial preservation (’386 Pat. at 12:24–67).

25 Patent owner argues that defendant’s own marketing materials admit that the MIBIScope
26 “detects and analyzes at a single cell level,” and that this capability somehow betrays that it
27 sequentially analyzes cells as claimed. On the contrary. The cited materials tout the
28 MIBIScope’s *subcellular* analysis and location preservation capabilities (Dkt. Nos. 161-4 at 5;

1 162-12 at 2; 162-13 at 1–2; 162-14; 162-15 at 2; 162-16; 161-13 at 1). But this just illustrates
2 that the MIBIScope may analyze several pixels falling within a single cell on the sample slice.
3 It still does not operate on whole cells in sequence as claimed, so this argument does not bridge
4 the fundamental gap between the claimed method of cell-by-cell analysis and the MIBIScope’s
5 pixel-by-pixel scanning.

6 In sum, the MIBIScope does not “sequentially” detect the transient signals of both a first
7 and a second cell. Patent owner offers no alternate literal infringement theory in its own
8 motion or its opposition to defendant’s motion for noninfringement. This one failing for at
9 least the reasons given above, summary judgment of literal noninfringement is required.

10 **3. DOCTRINE OF EQUIVALENTS FAILS.**

11 Following the kerfuffle last summer about whether to admit a slew of late doctrine-of-
12 equivalents theories into this case, one might imagine those theories would make an
13 appearance in patent owner’s motion for summary judgment. They do not. Defendant,
14 nevertheless, still moves for judgment of noninfringement under these may-or-may-not-exist
15 theories on several grounds.

16 This order finds persuasive the contention that patent owner has abdicated its burden
17 under the ensnarement doctrine. The doctrine of equivalents permits a finding of infringement
18 where, though a claim does not literally read onto an accused product, the accused product
19 nonetheless “performs substantially the same function in substantially the same way with
20 substantially the same result as” as the claim limitation. *Intendis GMBH v. Glenmark Pharms.*
21 *Inc.*, 822 F.3d 1355, 1360 (Fed. Cir. 2016). But “[a] doctrine of equivalents theory cannot be
22 asserted if it will encompass or ‘ensnare’ the prior art.” So, “[a] hypothetical claim analysis is
23 a practical method to determine whether an equivalent would impermissibly ensnare the prior
24 art.” *Jang v. Boston Sci. Corp.*, 872 F.3d 1275, 1285 (Fed. Cir. 2017) (quotation marks
25 omitted).

26 The hypothetical claim analysis proceeds in several steps. The patentee articulates a
27 “hypothetical claim that literally covers the accused device.” Next, the accused infringer
28 produces prior art to challenge the hypothetical claim. Then the patentee must prove that the

1 hypothetical claim evades the prior art. *Ibid.*; *Streamfeeder, LLC v. Sure-Feed Sys.*, 175 F.3d
2 974, 983 (Fed. Cir. 1999). As defendant notes, however, patent owner has offered no
3 hypothetical claim for evaluation, despite the opportunity to present one here.

4 Either misreading or mischaracterizing the caselaw, patent owner asserts that an accused
5 infringer must identify specific prior art before any ensnarement analysis occurs. Not so. The
6 ensnarement analysis begins with the patent owner’s articulation of a “hypothetical claim that
7 literally covers the accused device.” *Jang*, 872 F.3d at 1285–87. Patent owner does not
8 contend it is not on notice of defendant’s ensnarement defense. So, it must articulate an
9 adequate hypothetical claim. It has failed to do so.

10 Patent owner falls back on the undersigned’s previous statement that “[b]efore any
11 ‘hypothetical claim analysis’ comes into play, the doctrine of equivalents must otherwise be
12 satisfied.” *Chiron Corp. v. SourceCF Inc.*, 431 F. Supp. 2d 1019, 1035 (N.D. Cal. 2006). But
13 patent owner disregards the circumstances of that statement. In *Chiron*, the patent owner
14 attempted to “collapse[] the entire doctrine of equivalents into a[n offensive] ‘hypothetical
15 claim analysis.’” In other words, the patent owner in *Chiron* was willing to engage in the
16 analysis.

17 Here, in contrast, patent owner has refused, and it will not be permitted to benefit from
18 such refusal. Where elected, the analysis remains a necessary step in the infringement theory.
19 Patent owner filed this case in September 2019. It is now January 2021. The Federal Circuit
20 has provided for the hypothetical claim analysis in the doctrine of equivalents context for at
21 least thirty years. *See Wilson Sporting Goods v. David Geoffrey & Assocs.*, 904 F.2d 677, 684
22 (Fed. Cir. 1990). Patent owner has enjoyed ample time to prepare for and engage in this
23 necessary step in its infringement theory. Having disclaimed that step, patent owner too
24 disclaims the theory.

25 CONCLUSION

26 Under the correct claim construction of the term “sequentially,” and on an undisputed
27 description of the operation of the accused product, the MIBIScope does not literally infringe
28 either the asserted Claim 9 of the ’386 Patent or Claim 6 of the ’698 Patent. Additionally,

1 patent owner has abdicated its burden under the doctrine of equivalents. Those theories fail as
2 well. Summary judgment of noninfringement of the asserted claims is **GRANTED**.

3 This order does not need to reach the bulk of the noninfringement or invalidity
4 arguments. It also does not reach defendant's (i) objection to portions of patent owner's
5 evidence; (ii) motion to strike patent owner's expert report for violation of the ADR Local
6 Rules; or (iii) motion to strike the untimely addition of accused products. This order also
7 reserves motions for sanctions or attorney's fees (whether pending or anticipated) until the
8 final resolution of the case.

9 A further case management conference is **SET** for **FEBRUARY 18 AT 11:00 A.M.** The joint
10 statement is due **FEBRUARY 11 AT NOON**. The parties shall please detail the remaining claims
11 and specify those *patent owner truly intends to press*.

12 **IT IS SO ORDERED.**

13

14 Dated: January 28, 2021.

15

16

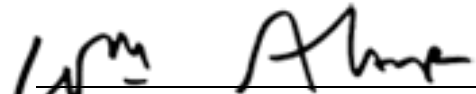

WILLIAM ALSUP
UNITED STATES DISTRICT JUDGE

17

18

19

20

21

22

23

24

25

26

27

28